

DS-2CD1327G0-L(UF) 2 MP ColorVu Fixed Turret Network Camera

ColorVu



Hikvision ColorVu technology provides 24/7 vivid colorful images with F1.0 advanced lenses and high performance sensors. F1.0 super-aperture collects more light to produce brighter images. Advanced sensor technology can vastly improve the utilization of available light.

- High quality imaging with 2 MP resolution
- Excellent low-light performance
- Efficient H.265+ compression technology
- Water and dust resistant (IP67)
- 24/7 colorful imaging

▪ Specification

Camera	
Image Sensor	1/2.8" Progressive Scan CMOS
Min. Illumination	Color: 0.001 Lux @(F1.0, AGC ON), 0 Lux with white light
Shutter Speed	1/3 s to 1/100,000 s
Slow Shutter	Yes
Wide Dynamic Range	Digital WDR
Angle Adjustment	Pan: 0° to 360°, tilt: 0° to 75°, rotate: 0° to 360°
Lens	
Focal Length & FOV	2.8 mm, horizontal FOV 105.2°, vertical FOV 56.5°, diagonal FOV 125.1° 4 mm, horizontal FOV 83.6°, vertical FOV 46.2°, diagonal FOV 97.5°
Lens Mount	M12
Focus	Fixed
Aperture	F1.0
DORI	
DORI	2.8 mm, D: 44.1 m, O: 17.5 m, R: 8.8 m, I: 4.4 m 4 mm, D: 53.4 m, O: 21.2 m, R: 10.7 m, I: 5.3 m
Illuminator	
Smart Supplement Light	Yes
White Light Range	Up to 30 m
Video	
Max. Resolution	1920 × 1080
Main Stream	50 Hz: 25 fps (1920 × 1080, 1280 × 720) 60 Hz: 30 fps (1920 × 1080, 1280 × 720)
Sub-Stream	50 Hz: 25 fps (640 × 480, 640 × 360) 60 Hz: 30 fps (640 × 480, 640 × 360)
Video Compression	Main stream: H.265/H.264 Sub-stream: H.265/H.264/MJPEG
Video Bit Rate	32 Kbps to 8 Mbps
H.264 Type	Baseline Profile/Main Profile/High Profile
H.265 Type	Main Profile
H.264+	Main stream supports
H.265+	Main stream supports
Region of Interest (ROI)	1 fixed region for main stream
Audio	
Audio Compression	-UF: G.711ulaw/G.711alaw/G.722.1/G.726/MP2L2/PCM/AAC
Audio Bit Rate	-UF: 64 Kbps (G.711ulaw/G.711alaw)/16 Kbps (G.722.1)/16 Kbps (G.726)/32 to 160 Kbps (MP2L2)/16 to 64 Kbps (AAC)
Audio Sampling Rate	-UF: 8 kHz/16 kHz
Environment Noise Filtering	-UF: Yes
Network	
Protocols	TCP/IP, ICMP, HTTP, HTTPS, FTP, DHCP, DNS, DDNS, RTP, RTSP, RTCP, NTP, UPnP™, SMTP, IGMP, QoS, IPv6, Bonjour, IPv4, UDP, SSL/TLS
Simultaneous Live View	Up to 6 channels
API	Open Network Video Interface, ISAPI

User/Host	Up to 32 users. 3 levels: administrator, operator and user
Client	iVMS-4200, Hik-Connect
Web Browser	Plug-in required live view: IE 10+ Plug-in free live view: Chrome 57.0+, Firefox 52.0+ Local service: Chrome 57.0+, Firefox 52.0+
Image	
Image Settings	Saturation, brightness, contrast, sharpness, AGC, white balance adjustable by client software or web browser.
Day/Night Switch	Day, Night, Auto, Schedule
Image Enhancement	BLC, 3D DNR
Interface	
Ethernet Interface	1 RJ45 10 M/100 M self-adaptive Ethernet port
On-Board Storage	-UF: Built-in memory card slot, support microSD card, up to 256 GB
Built-in Microphone	-UF: Yes
Hardware Reset	-UF: Yes
Event	
Basic Event	Motion detection, video tampering alarm, exception
General	
Linkage Method	Upload to FTP/memory card (-UF), notify surveillance center, send email, trigger recording (-UF), trigger capture
Camera Material	Metal & Plastic
Camera Dimension	∅109.9 mm × 103.6 mm (∅4.33" × 4.08")
Package Dimension	150 mm × 150 mm × 141 mm (5.9" × 5.9" × 5.6")
Camera Weight	Approx. 370 g (0.82 lb.)
With Package Weight	Approx. 580 g (1.28 lb.)
Storage Conditions	-30 °C to 60 °C (-22 °F to 140 °F). Humidity: 95% or less (non-condensing)
Startup and Operating Conditions	-30 °C to 60 °C (-22 °F to 140 °F). Humidity: 95% or less (non-condensing)
Web Client Language	English, Ukrainian
General Function	Anti-flicker, heartbeat, mirror, password protection, privacy mask, watermark, IP address filter
Firmware Version	V5.5.122
Power Consumption and Current	12 VDC, 0.4 A, max. 5 W PoE: (802.3af, 36 V to 57 V), 0.2 A to 0.15 A, max. 6.5 W
Power Supply	12 VDC ± 25% PoE: 802.3af, Class 3
Power Interface	∅5.5 mm coaxial power plug
Approval	
EMC	FCC SDoC (47 CFR Part 15, Subpart B); CE-EMC (EN 55032: 2015, EN 61000-3-2: 2014, EN 61000-3-3: 2013, EN 50130-4: 2011 +A1: 2014); KC (KN 32: 2015, KN 35: 2015)

Safety	UL (UL 60950-1); CB (IEC 60950-1:2005 + Am 1:2009 + Am 2:2013, IEC 62368-1:2014); CE-LVD (EN 60950-1:2005 + Am 1:2009 + Am 2:2013, IEC 62368-1:2014); BIS (IS 13252(Part 1):2010+A1:2013+A2:2015)
Environment	CE-RoHS (2011/65/EU); WEEE (2012/19/EU); Reach (Regulation (EC) No 1907/2006)
Protection	IP67 (IEC 60529-2013)

▪ **Available Model**

DS-2CD1327G0-LUF(2.8mm/4mm)(C)

DS-2CD1327G0-LUF(2.8mm/4mm)(C)

▪ **Dimension**

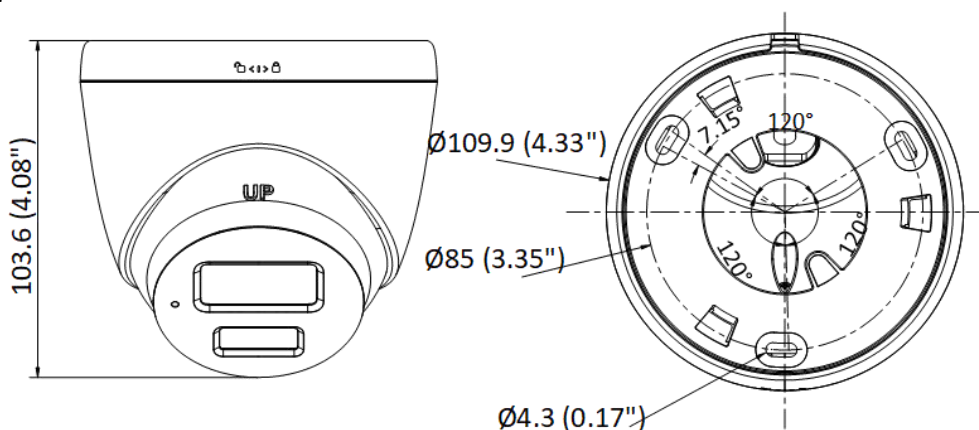













Unit: mm (inch)

▪ **Accessory**

▪ **Optional**

DS-1272ZJ-110B Wall mount	DS-1272ZJ-110 Wall mount	DS-1271ZJ-110 Pendant Mount	DS-1275ZJ-SUS Vertical pole mount	DS-1276ZJ-SUS Corner mount

DS-1280ZJ-S Junction box	DS-1281ZJ-S Inclined ceiling mount	DS-2280ZJ-WA110 Junction box	DS-2210ZJ-WA-110 Pendant Mount	DS-2200ZJ-WA-110 Wall mount
				
				
DS-2200ZJ-WAJ-110 Wall mount				
				
				

Headquarters

No.555 Qianmo Road, Binjiang District,
Hangzhou 310051, China
T +86-571-8807-5998
www.hikvision.com



Follow us on social media to get the latest product and solution information.

